

PORTA TRAK OWNERS MANUAL

Please read the instructions thoroughly before setting up the Porta Trak. Carefully follow how to spring the bed step by step.

Table of Contents:

- I. Rail and Frame Parts List
- II. Rail and Frame Assembly
- III. Springing the Porta Trak Bed
- IV. Diagrams
 - 1. Appendix A) Assembly Diagram
- V. Porta Trak Checklist and Care
 - a. After Assembly check list
 - b. Maintenance Checks for the Porta Trak
 - c. Tumbling with Porta Trak
 - d. Safety Suggestions for Use on the Porta Trak

TOOLS NEEDED FOR ASSEMBLY

- 7/32 Hex wrench
- Two 9/16 wrench

	! WARNING
<ul style="list-style-type: none">• Serious injury (including permanent paralysis or death) could result from any activity involving motion, rotation or height.• All users of this equipment assume this risk of serious injury.• Mats and pits cannot and do not eliminate hazards.	
Safety Instructions	
ALWAYS: <ul style="list-style-type: none">1. Consult an instructor prior to use.2. Use equipment ONLY under the supervision of trained and qualified instructors.3. Use equipment with trained spotters and the proper spotting equipment.4. Check equipment before use for proper positioning; equipment can move during use.5. Follow a progressive learning pattern. Assure basic skills are achieved before attempting more advanced skills.6. Use equipment ONLY when all hard exposed surfaces are protected with proper mats.7. Assure that all inflatable equipment has sufficient air pressure to avoid injury.	
DO NOT use the apparatus with damaged, worn or missing parts.	
DO NOT allow more than one person at a time to use the equipment.	



***Congratulations on your acquisition of a Tumbl Trak™ product!** The Tumbl Trak™ Line of Equipment has been designed and developed with the gymnastics coach **and** athlete in mind. Tumbl Trak™ is dedicated to helping young athletes train smarter.*

I. Rail and Frame Parts List

15' Porta Trak

- [Qty 2]: 15' hinged rails
- [Qty 4]: Legs w/ Casters
- [Qty 4]: Legs w/ no Casters
- [Qty 16]: Hex Bolt 3/8-16 x 3-1/4 Grade 5 Plated
- [Qty 16]: Hex Nut 3/8-16 Nyloc

* You will need two 9/16 wrenches

20' Porta Trak

- [Qty 2]: 15' hinged rails
- [Qty 6]: Legs w/Casters
- [Qty 6]: Legs w/ no Casters
- [Qty 2]: 2.5' extension rail pieces (left)
- [Qty 2]: 2.5' extension rail pieces (right)
- [Qty 4]: Attachment plates w/ 32 '3/8 x 1 in. Allen Head Bolts & Nuts
- [Qty 20]: Hex Bolt 3/8-16 x 3-1/4 Grade 5 Plated
- [Qty 20]: Hex Nut 3/8-16 Nyloc

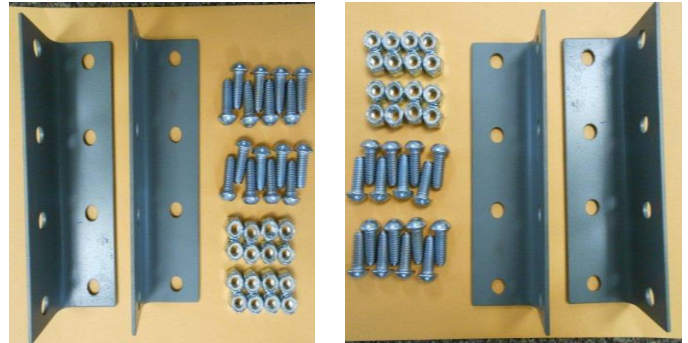

*You will need a 7/32 Hex wrench and two 9/16 wrenches

30' Porta Trak

- [Qty 4]: 15' hinged rails
- [Qty 8]: Legs w/ Caster
- [Qty 8]: Legs w/ no Casters
- [Qty 2]: Attachment plates w/ 16 '3/8 x 1 in. Allen Head Bolts & Nuts
- [Qty 16]: Hex Bolt 3/8-16 x 3-1/4 Grade 5 Plated
- [Qty 16]: Hex Nut 3/8-16 Nyloc



*You will need a 7/32 Hex wrench and two 9/16 wrenches

II. Rail and Frame Assembly

1. Rail Assembly for 20' and 30' Units

- A. Assemble hinge rails prior attaching to legs.
- B. Use the attachment plates to fasten the 15' hinged rail to the 2.5' extension rail piece (Appendix A) with the 3/8-16 x 3-1/4 Hex Bolts and Nuts (See Fig. 1). Ensure the threads of the screws are facing inside the rail (See Fig 2). Secure with Hex Nuts.

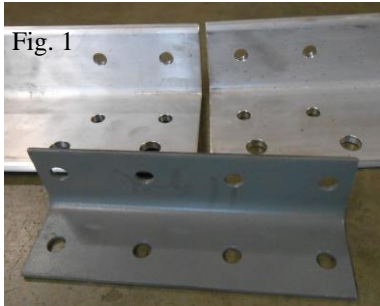

***Refer to Appendix A. assembly Diagrams**

2. Frame Assembly

- A. Lay the 2 assembled Porta Trak rails parallel to each other approximately 6 feet apart with holes facing inward.
- B. Stand the legs upright so that the plastic cap end is on the floor. The legs will run perpendicular to the length of the Porta Trak (like railroad ties). Place legs with casters as indicated in **Appendix A** (See Fig. 1).
- C. Connect the legs to the rails by placing rails onto legs (See Fig. 2). Install the 3/8-16 x 1/4 Hex Bolts provided through the holes indicated in Fig. 3&4 and fasten nuts. ***The Hex Bolts provided are meant to be longer than the Porta Trak legs to prevent damage to the aluminum frame from over tightening.***

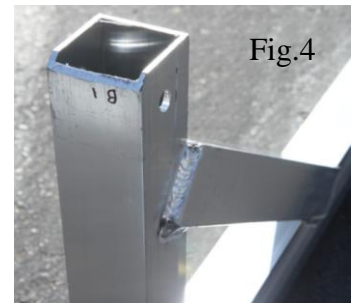
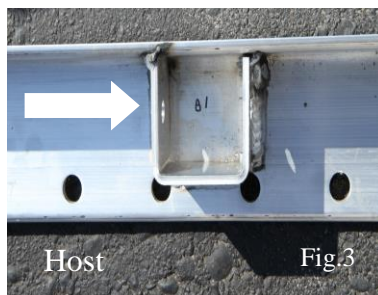

***Refer to Appendix A. Assembly Diagrams**

III. SPRINGING THE BED

1. Springing the Bed

- A. Decide which end of the bed will be used as the "take off" end. Start springing the bed on this end. *****The "take-off end" is where the athletes dismount onto a mat.***
- B. Hook two spring ends on the **first** D-ring (the silver rings that are sewn along the edges of the bed). Take the first spring in the first D-Ring and attach to the first hole in the rail. You will then take the second spring in the first D-Ring and attach it to the second hole in the rail. (See Fig. 5)
- C. The third spring will attach to the **second** D-ring and hook to the **third** rail hole.
- ALWAYS ATTACH HOOKS DOWNWARDS!!!** (See figure 8 at bottom)
- D. Repeat on the other side. Use the Springing Tool if necessary (See Section 2 for Springing Tool instructions).
- E. Springing the bed will be much easier and quicker if you have another person hand springing the opposite side **first** on the Porta Trak while you are using the Springing Tool to spring your side. When hand springing the opposite side of the Porta Trak, be sure to stay at **least** 4-5 springs ahead of the person using the Springing Tool. It will be necessary to **skip a Rail Hole** (not a D-Ring) within the first 15-20 holes to keep the bed wrinkle free. The **D-Ring** (not rail hole) on the bed across from the hinge will be **skipped**, to allow the Porta Trak to fold. (**Figure 8**). If you are setting up the Porta Trak by yourself, hand spring 4-9 springs on one side then alternate to the other side and continue to use the Springing tool to spring 2-7 springs before you alternate to the other side again. By continuing down the bed further on the hand sprung side, the amount of effort to hand spring will remain low. When the bed is attached properly, it should be smooth and tight.
- H. The last 2-3 springs will attach to the frame at an **angle**. This will keep the bed tight.
- I. After all D-rings have springs attached to them, **double spring** the last d-rings on each side of the frame. The springs may be difficult to hook, but will provide extra support for the end of the bed.



For Safety and liability reasons, the Porta Trak's polypropylene bed should be replaced every 5-6 years

Because of the manufacturer's variance in the length of Porta Trak beds, your bed may be slightly shorter or longer than the length of the Workstation frame.

Figure 8
(Spring angle slightly exaggerated)

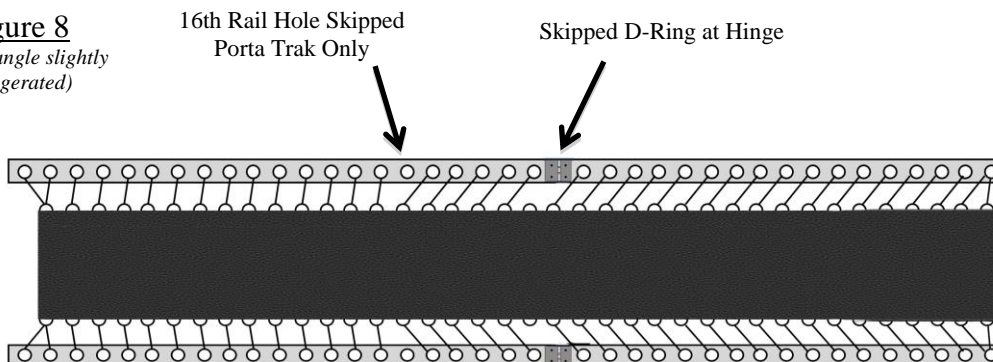

2. Using the Springing Tool

This model has been designed for easier use. The bent end of the thicker rod fits in a frame hole one down from the hole into which you want to place the spring. Use the smaller hook to stretch the spring onto the tool handle. With your other hand, help place the spring into the desired hole. ****Watch your hands!!!** You should use gloves (See Fig. 6).

(Watch this video for a demonstration on how to use the springing tool)

https://www.youtube.com/watch?v=Qo4vp_kDFUsl



3. Attaching the Frame Pads and End Caps

- A. Attach the pressure sensitive loop Velcro on the outer edge of the holes on the Porta Trak rails leaving 6” extra at each end to attach the endcaps.
- B. Align the pre-sewn Velcro on the pads with the Velcro strip on the Porta Trak rails.
- C. Make sure the springs, frame, and bed flaps are covered by the pads.
- D. Attach an endcap to each of the four corners of the Porta Trak.
- E. *Use the extra 6” of Velcro to wrap around the endcap and fasten the Velcro to the underside of the rail (See Fig. 7).*

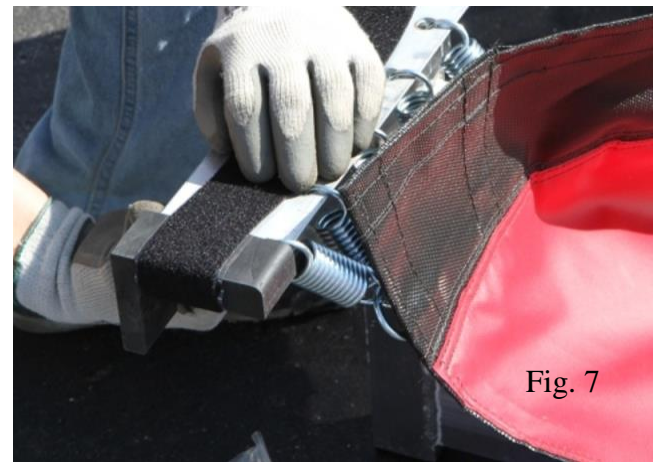

4. Folding the Porta Trak

You will need to remove the pads on the frame *before* folding. ***Folding the frame with the pads still attached may cause the hinge to break.*** Two or more people are recommended to lift the end of the Porta Trak, make sure to check for overhead clearance.

5. Transporting the Porta Trak

After the unit is folded, lift the folded Porta Trak onto the side with the wheels attached. The unit should be slowly rolled when moving. To open, again use two or more people. The pads will need to be put back on when you set it back up. Reverse procedure to setup after transference.

Be very careful when folding and transporting any Porta Traks. Always use appropriate assistance.

Appendix A. Assembly Diagram

❖ 15ft Porta Trak Assembly Diagram

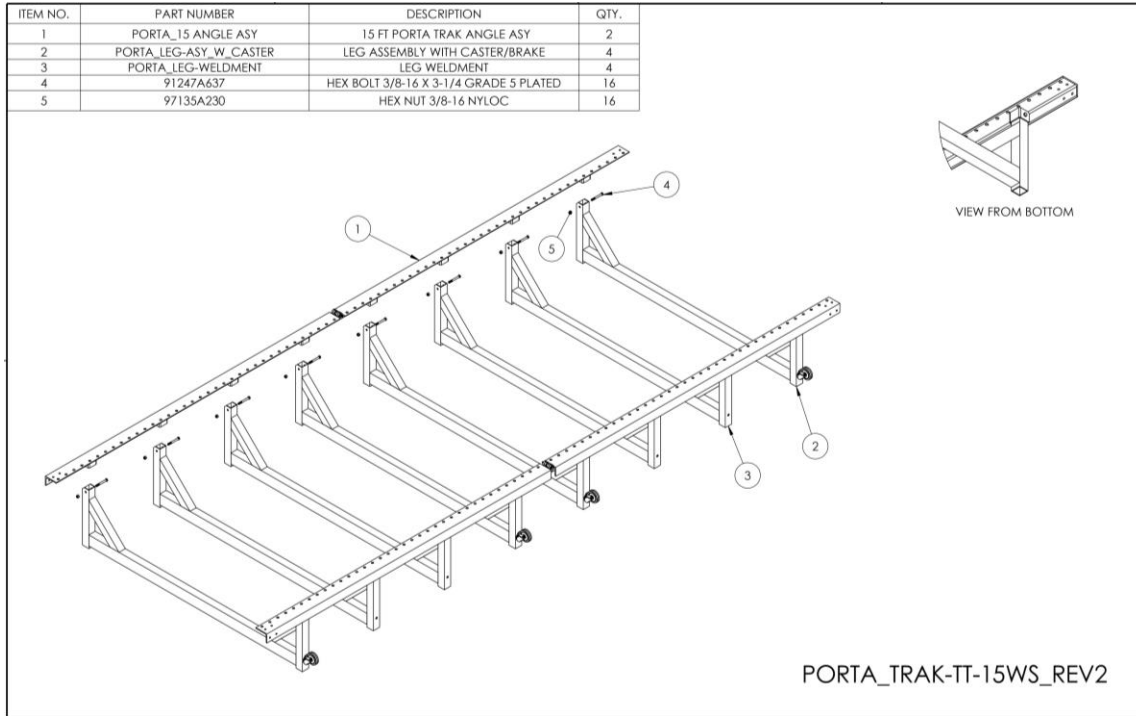

❖ 20ft Porta Trak Assembly Diagram

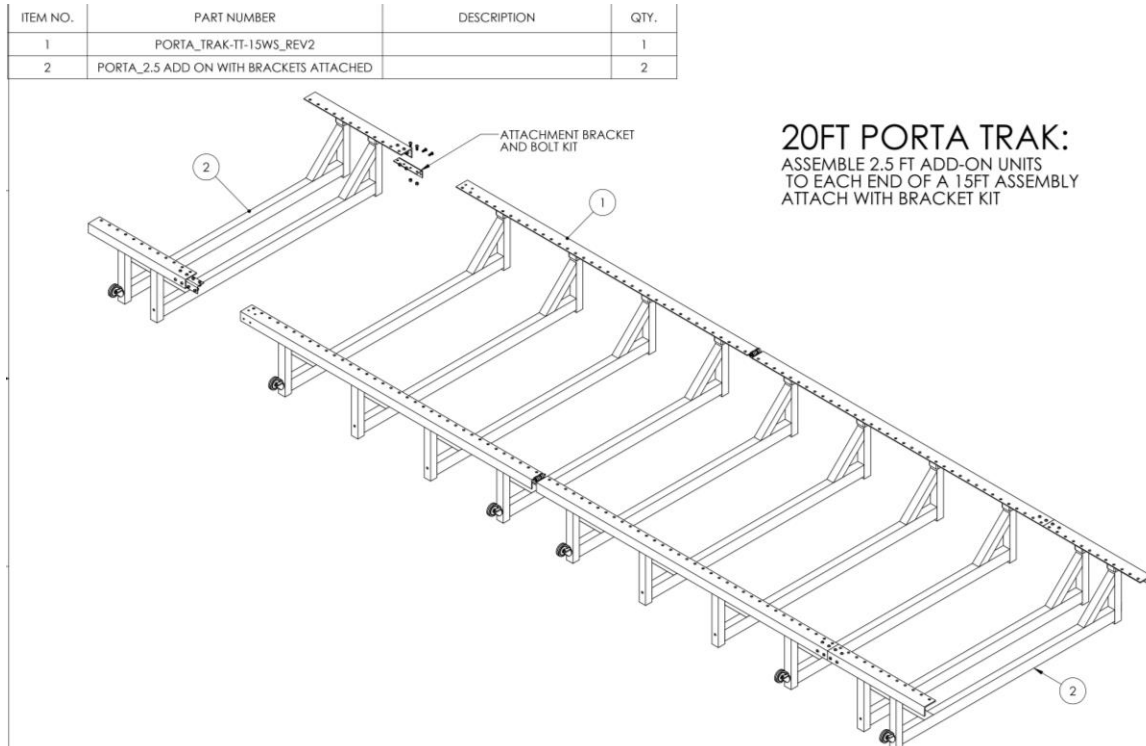

❖ 30 ft Porta Trak Diagram

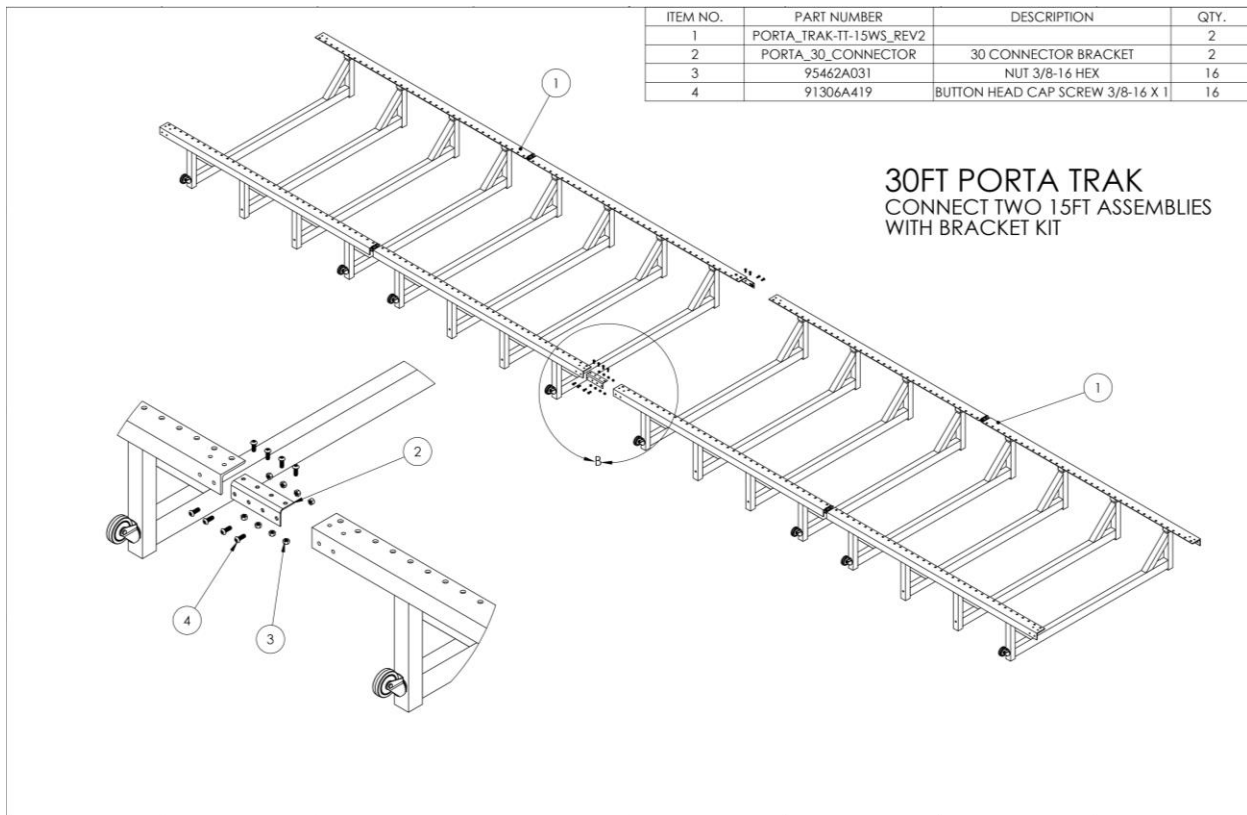

IV. Porta Trak Check List and Care

1. After Assembly Checklist

After you have successfully assembled your Porta Trak, check the following points:

- A. **Is the bed of the Porta Trak smooth?** If it is wrinkled, check your assembly instructions (written or DVD), and re-spring the appropriate springs to draw the bed smooth. Commonly, new owners will forget to skip a hole on the Porta Trak frame.
- B. Check to see that the Frame Pads are securely connected to the frame with Velcro, and that they cover the entire frame and springs.
- C. Check the landing surface at the end of your Porta Trak. Tumbl Trak's™ Porta Trak Dismount Mat has straps that fasten to the end of the frame. The end of the mat should be placed under the "take-off" end of the Porta Trak so that it rests against the last leg of the Porta Trak. Tumbl Trak's™ Porta Trak Dismount Mat has been designed specifically to be paired with Tumbl Trak's™ Porta Trak.
- D. Post the included Safety Poster in a visible area near your assembled Porta Trak.

2. Maintenance Checks for the Porta Trak

A. Daily:

- ★ Check to see that the pads are securely in place on the frame of the Porta Trak.
- ★ Check to see that the landing surface is set up for use in appropriate fashion.
- ★ (If applicable) Check to see that the runway and/or ramp is secure to the Porta Trak frame and to each other.
- ★ **Tip:** If you purchased a folding ramp with your Porta Trak, you may want to attach a strip of loop Velcro to the bed of the Porta Trak. The flap on the ramp will fasten to this Velcro strip, securing the ramp to the Porta Trak.

B. Weekly:

- ★ Check the bed of the Porta Trak once every week for wear. On some occasions the seam, near the edge where the D-rings are sewn, can show a stretch in the black polypropylene material. It is common to have a stretch of to 1 inch.
- ★ If there is a greater stretch, or any of the strands of material have actually torn, discontinue use and contact Tumbl Trak™ at 1-800-331-4362.

C. Monthly:

- ★ Check the welds on the Porta Trak frame.

3. Tumbling with Porta Trak

A. Remember that the Porta Trak has more “spring” than most tumbling surfaces. Your beginner to advanced athletes may need to start slowly when tumbling on the Porta Trak; there is the potential to over-power skills. Tumbl Trak™ suggests gymnasts start the skill standing and progress before going “all out.” Make careful preparations to measure the approach to the take-off end of the Porta Trak. Gymnasts often dismount too close to the end of the bed. The red vinyl with the Tumbl Trak™ logo provides a visual cue to help gymnasts take-off.

4. Safety Suggestions for Use of the Porta Trak

B. Tumblers should be able to tumble in a straight line before using the Porta Trak.

C. The Porta Trak should be used UNDER PROPER SUPERVISION ONLY.

D. Explain to all new participants that the Porta Trak has more "spring" than most other tumbling surfaces, and that it should be approached with care. For example, it is very easy to over-rotate skills on the Porta Trak. Tumblers may barely be able to perform these skills on another surface. Over-rotating tumbling skills on or off of the Porta Trak can be risky and dangerous. A shorter and easier approach to a tumbling pass (rather than a hard run) will usually be more than sufficient on the Porta Trak.

E. Tumbling with 1.25" or 2" mats (such as panel mats or carpet-bonded foam) is an excellent way to slow down the tumblers and allow them to feel as if they are tumbling on a more traditional surface.

F. We suggest that the Porta Trak be set up with a mat that is 12 inches thick, a loose foam pit or a "resi"-pit at the "take-off" end. Tumbl Trak™ can supply a 6'x12'x12" thick mat with a connecting device so that the mat is attached to the frame. The mat will fit under the colored Tumbl Trak™ Logo on the bed and up against the frame; so that tumblers who take off too near the end of the bed will have a mat to protect them. Although the Porta Trak can certainly be used as a landing surface for more difficult skills, it is more appropriate to take a progressive approach to the training of aerial skills. If athletes are dismounting into a pit, please check industry standards for specifications. Tumbl Trak™ recommends that the bottom and ALL sides of the pits have padding.

G. Be familiar with the Porta Trak information that has been provided to you.

H. Perform Porta Trak maintenance checks as suggested in this Porta Trak owner's manual.

Skipping steps in the progressions suggested above may be dangerous, because the participant may not be mentally or physically prepared to perform the skill safely. Neither the Porta Trak, spotters, nor mats are any substitute for proper training. Coaches should never assume that any of these can take the place of proper training. For proper technique please refer to the enclosed DVD or visit our Training Tips at www.tumbltrak.com.